



AW-5600AT

Fully integrated weigh-wrap-label system



Searching for a New Balance

AW-5600AT strongly and efficiency supports the prepackaging operation and lowers total costs

The AW-5600AT is a compact but robust weigh-wrap-label system. Super-wrap technology smoothes the prepackaging operation and reduces film consumption, drastically increasing the efficiency of the total operation.

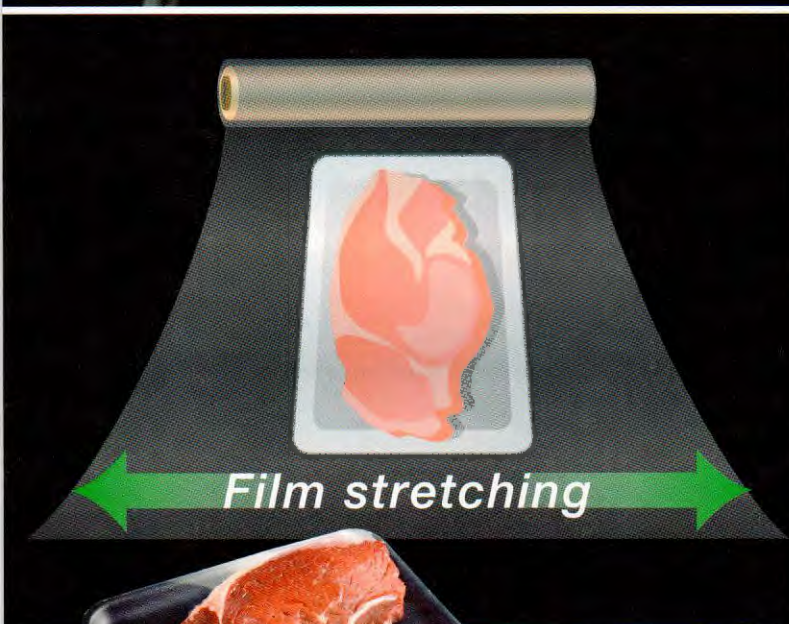
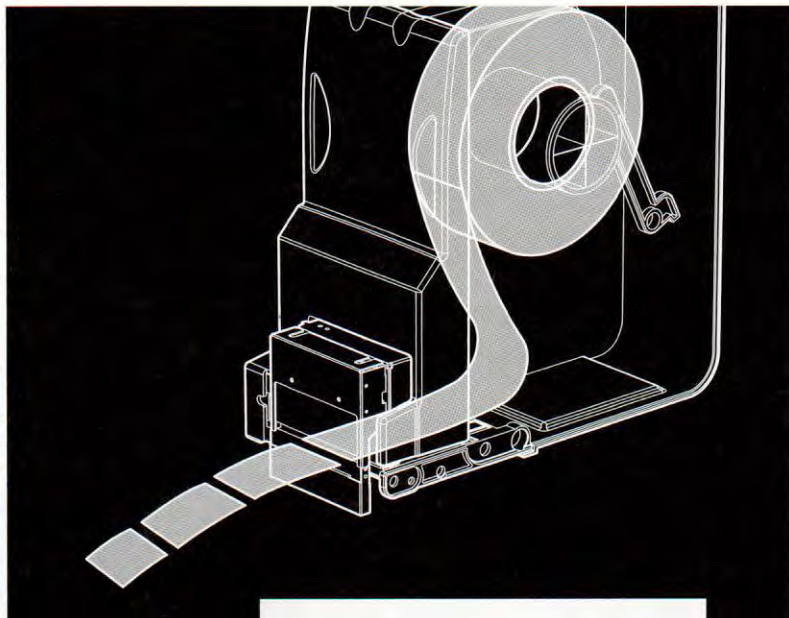
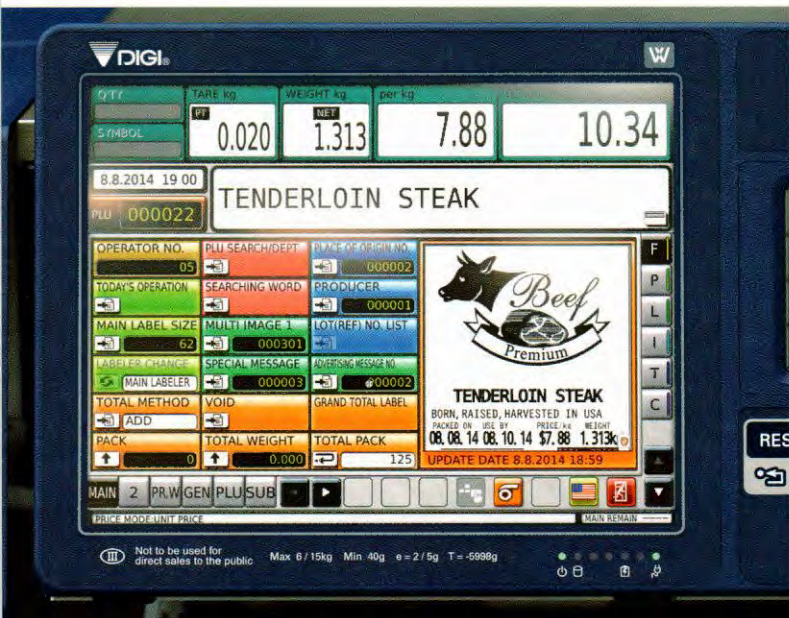

Actual size

User friendly extra-large 12.1" full color touch screen

- Preset and frequently used function keys can be assigned for quick access. Size, color and location can be changed to suit your operation.
- Label print content can be previewed on the display, helping to prevent labeling errors.
- Extremely large memory easily supports increasing need for print items.

Super-stretch technology removes tedious adjustments

- DIGI's unique super-stretching technology allows dynamic film savings.
- AW-5600AT automatically determines the optimum wrapping conditions required to wrap the package.
- The film will be stretched to the required size to wrap the package enabling one roll of film to cover most of the trays in a store.

New 80mm width 300 dpi thermal head

A new 300 dpi thermal head enables clear and crisp label print. The 80mm of print width still allows large label sizes to be used for more information when needed. Head security function is equipped as standard, to prevent dot missing.

Accurate label placement

Robot arm labeling system automatically applies labels on the trays. The position and the angle can be selected per PLU.



AW-5600AT TWIN POP BP

Labeling options

AW-5600AT can be equipped with several labeler options.

- Twin labeler
- POP labeler
- Bottom labeler

Small foot print

AW-5600AT requires a small area for installation.

Easy film change

Easy film loading can be done from the front of the machine making operation downtime minimal.



ex. 86mm ▶ 60mm

No more wasted white space on big labels

The auto-label-sizing feature eliminates unused space on the label and automatically adjusts the label size. This reduces the label cost and makes labels more attractive.

Increased flexibility in label format

The auto-cut feature cuts from a continuous strip of linerless labels every time a label is printed. Variable label layouts and sizes can be printed from a single roll.

Linerless option available

Choose the AW-5600AT LL for linerless label operations. Eliminate liner waste and increase flexibility and profits.

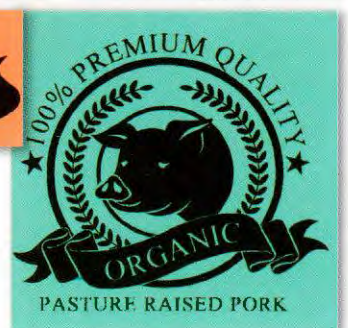

Specifications

Wrapping

Package size ----- Width: 130-380mm (5.1-15 inches)
 * Height: 10-130mm (0.4-5.1 inches)
 * Depth: 80-254mm (3.1-10 inches)

Wrapping speed ----- Max. 36 packages/min.
 Number of film roll ----- One roll
 Film width ----- 300-450mm (12-18 inches)
 Film length ----- Max. 1,500m (4,900 feet)

* 150mm (5.9 inches) as factory option

** The combination of maximum size of each dimensions cannot be used. The size of the package size can be wrapped also depends on the film to use.

Weighing

Interval type	Multi-interval		Single interval
Capacity	Max. 3/6kg	Max. 6/15kg	Max. 30 lb.
Scale interval	e=1/2g	e=2/5g	e=0.01 lb.
Weighing range	20g-6kg	40g-15kg	0.20-30 lb.
Max. wrapping capacity	5kg	5kg	11 lb.

Printer and labeler

Type ----- Thermal printer
 Dot density ----- 12 dot/mm (300dpi)
 Printing width ----- 40-80 mm (1.6 to 3.1 inches)
 Printing length ----- 28-105 mm (1.1 to 4.1 inches)

Label size ----- Width: 40-80mm (1.6-3.1 inches)
 Length: 28-105mm (1.1-4.1 inches)
 Label roll diameter ----- Max. 210 mm (8.2 inches)
 Label roll core diameter ----- 76 mm (3.0 inches)

Operation console

Display panel ----- TFT LCD color (12.1 inches)
 Operation keys ----- Mechanical function keys and touch screen
 Memory for programmable files ----- 8.8GB

General

Power source and power consumption ----- • 208/240V; 3Phase; 50/60Hz; 2.7kVA
 • 220-240V; 1Ø; 50/60Hz; 7.5A; 1.7kW
 Dimensions ----- 1410/55.5(W)x1535/60.4(D)x1465/57.7(H) mm/inches
 Net weight ----- Approx. 400kg/882lbs (Single Labeler Type)
 Operation humidity ----- 90%RH (max.) with no condensation

Options

- POP Labeler
- Second Labeler
- Bottom Labeler
- Linerless Labeler

Dimensions

Top View

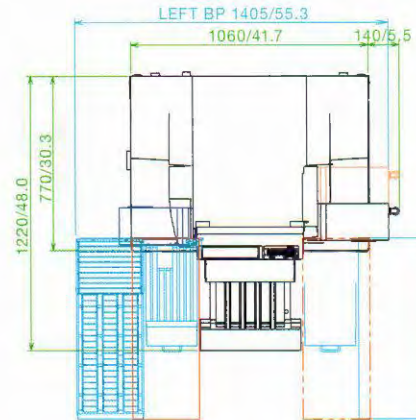

Front View

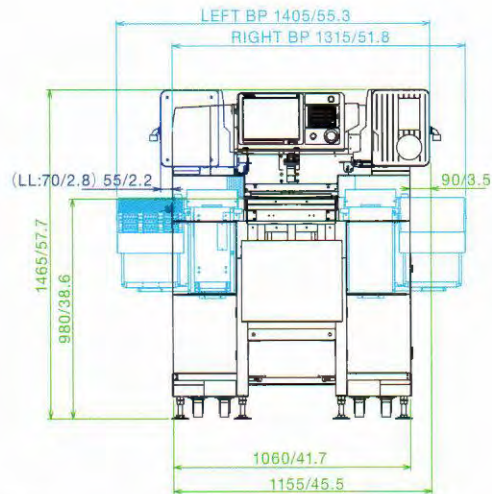

Side View

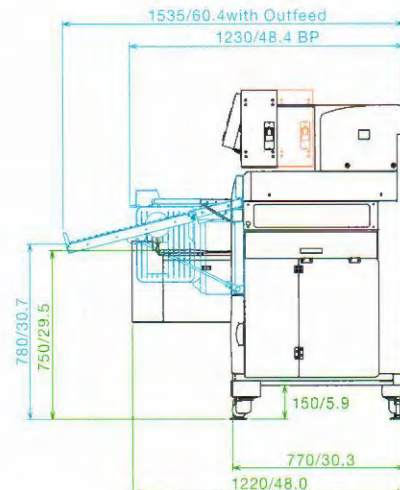

*Specifications are subject to change without prior notice.

TERAOKA SEIKO CO., LTD.

13-12 Kugahara 5-chome, Ohta-ku,
 Tokyo 146-8580 JAPAN
 www.digisystem.com



la competencia s.a.
 PONE EL CONTROL EN SUS MANOS
 Pasaje N44B No. E10-26 Intersección Av. 6 de Diciembre Teléfono: (593) 2 396-5200
 www.competencia.com.ec ventas@competencia.com.ec

A1410CDMP